

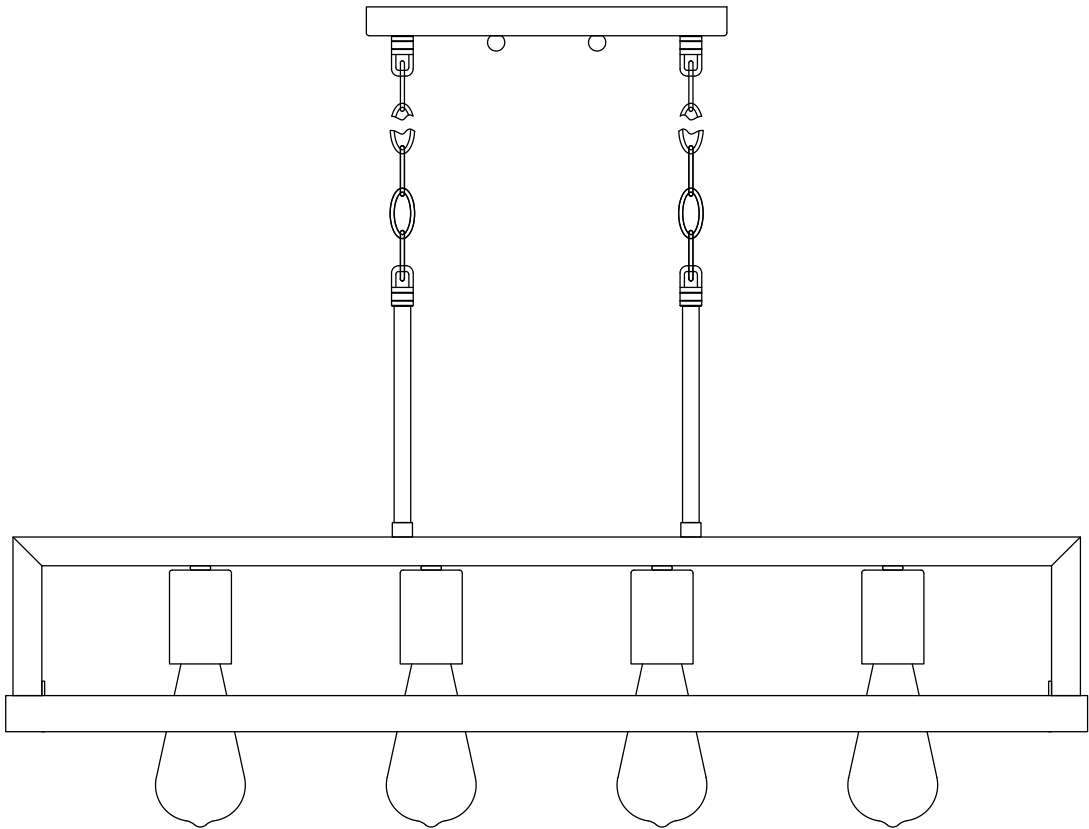

PRODUCT NAME: Black Forest 4 Light Chandelier
ITEM NUMBER: 10307

Please consult your electrician for hanging fixture and wiring.



Bulbs (Not Included) : E26 4*60W ST64

IMPORTANT: Turn off the power at the main fuse or circuit breaker box before starting installation

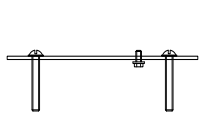

Bracket(A)

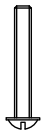

Mounting Screws(B)



Finial(C)

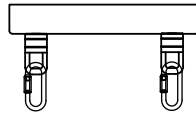

Canopy(D)

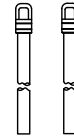

Stems(F)

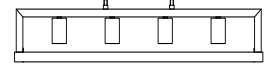

Fixture(G)



Bulb(H)

Locate all hardware & components before discarding packaging

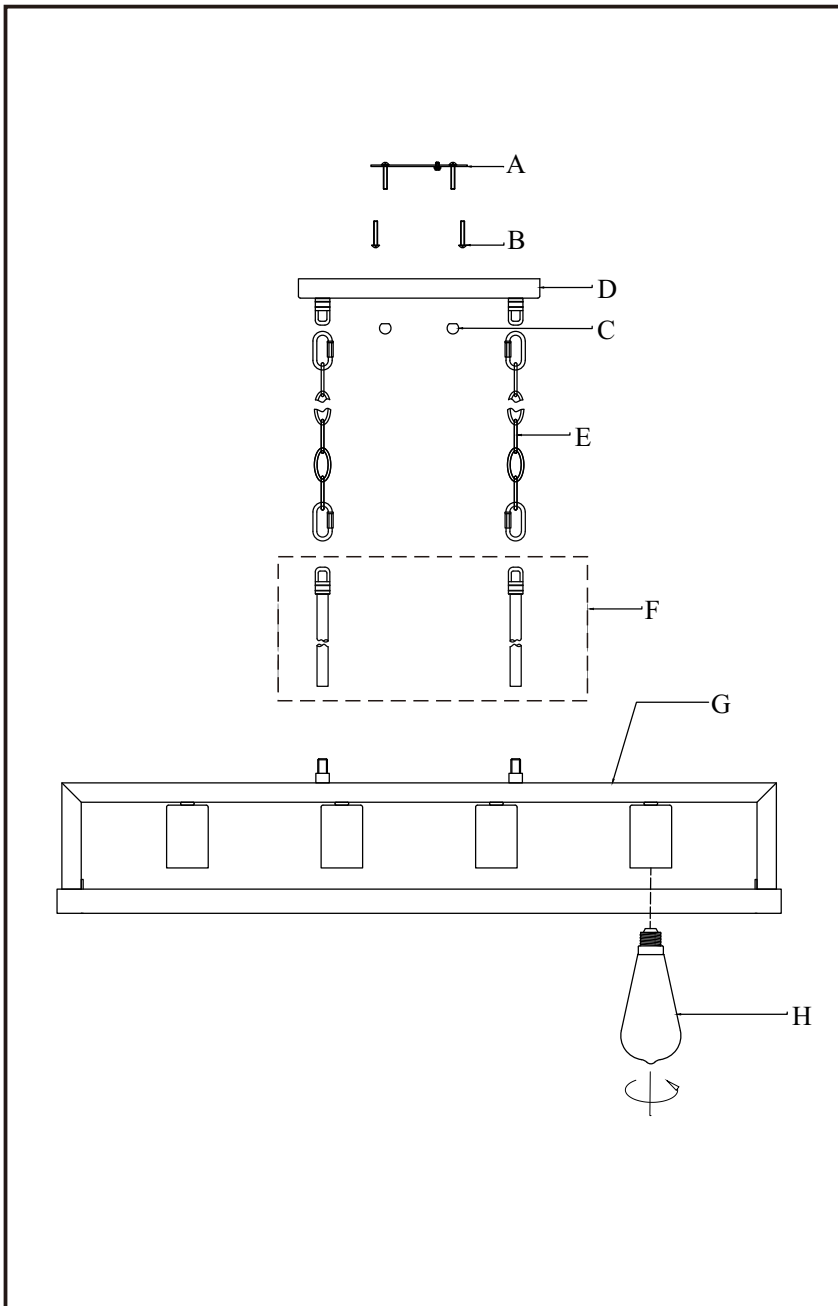

1.)

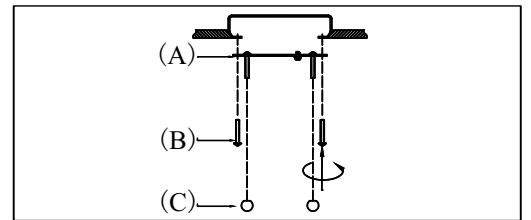

Step1 : Remove mounting bracket from fixture and install to electrical box.

2.)

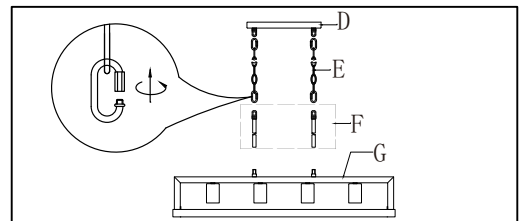

Step.2: Install top loop E to center stem and attach appropriate amount of chain to loop to achieve desired mounting height.

3.)

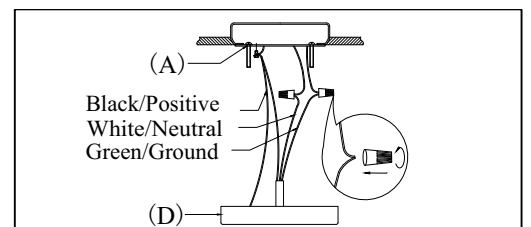

Step3 : Wire fixture to wires in outlet box. Green wire is for Ground.

4.)

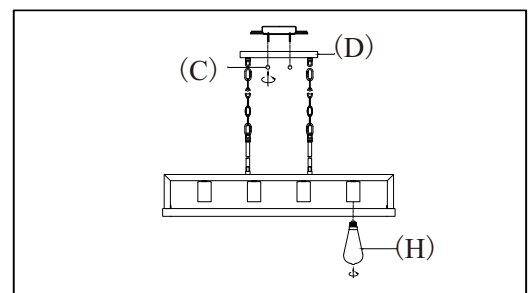

Step4 :Install fixture to bracket and tighten screws at the ends of the canopy to secure.then install the bulb(H)

Cleaning & Care:

Clean with soft cloth and a mild detergent.
Do not use abrasive cleaner.