

PRODUCT DESCRIPTION

A sea of crystal strands suspend from within drums of steel which are finished in your choice of Bronze with Scotch crystal or Polished Chrome with Mirror Smoke crystal. Hidden inside the drum is a powerful dimmable LED source which has the crystals dancing in the night without any glare in your eyes.

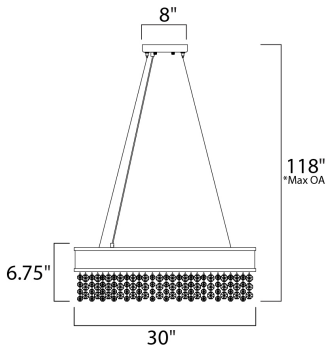

*max overall height

MEASUREMENTS

DIMENSION : 30" L x 30" W x 6.75" H
 MAX OAH : 118" OAH
 CANOPY : 7.87" W x 1.57" H x 7.87" L
 HANGING WEIGHT : 50.34 lb

LAMPING

INPUT VOLTAGE : 120V
 LUMENS : 4,312 Rated (3,300 Del.)
 BULB : 22 x 3W LED PCB Integrated , 66W Total
 BULB INCLUDED : (Integrated)
 DIMMABLE : Triac CL
 CRI : 80+ CRI
 COLOR_TEMP : 3000K

FINISHES OPTION

- Bronze
- Polished Chrome

GLASS

Scotch Crystal SH

MATERIAL

Stainless Steel, Crystal

RATINGS

cETLus
 Dry Location



ADDITIONAL

OPERATING TEMPERATURE:
 -20°C (-4°F), 40°C (104°F)

Always consult a qualified electrician before installing any lighting product.



WESTERN DISTRIBUTION CENTER (HEADQUARTER)
 253 NORTH VINELAND AVE | CITY OF INDUSTRY, CA 91746
EASTERN DISTRIBUTION CENTER
 4200 SHIRLEY DR. | ATLANTA, GA 30336
 P. 626.956.4200 | F. 626.956.4225 | maximlighting.com