

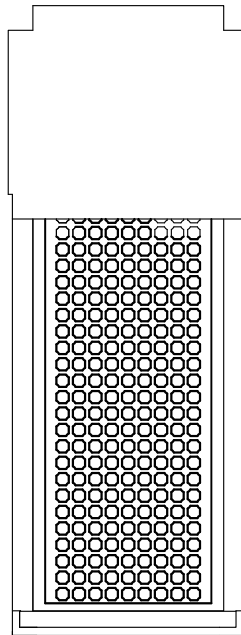

PRODUCT NAME: Townhouse 1-Light
ITEM NUMBER: 53597

Please consult your electrician for hanging fixture and wiring.



To prevent water intrusion, caulk around back-plate where fixture meets the wall using outdoor silicone sealant. Leave a small gap at the bottom to allow moisture to exit.

The fixture is designed to dim with a standard Triac forward phase dimmer. Dimming levels will vary by dimmer. Below is a list of recommended dimmers:

- Lutron MACL-153M
- Lutron DVL-153P
- Lutron SCL-153P
- Leviton IPL06-10Z
- Leviton 6674-POW

Due to inrush current, wattage should not exceed 150 watts of product for a 600W dimmer.

WARNING: Wires need to be connected to driver found in canopy and should not be connected directly to power source or a short may occur.

7W LED



PRODUCT NAME: Townhouse 1-Light
ITEM NUMBER: 53597

CAUTION: Before starting the installation, disconnect the power by turning off the circuit breaker or by removing the fuse at the fuse box.

Carefully unpack and identify all parts before assembly

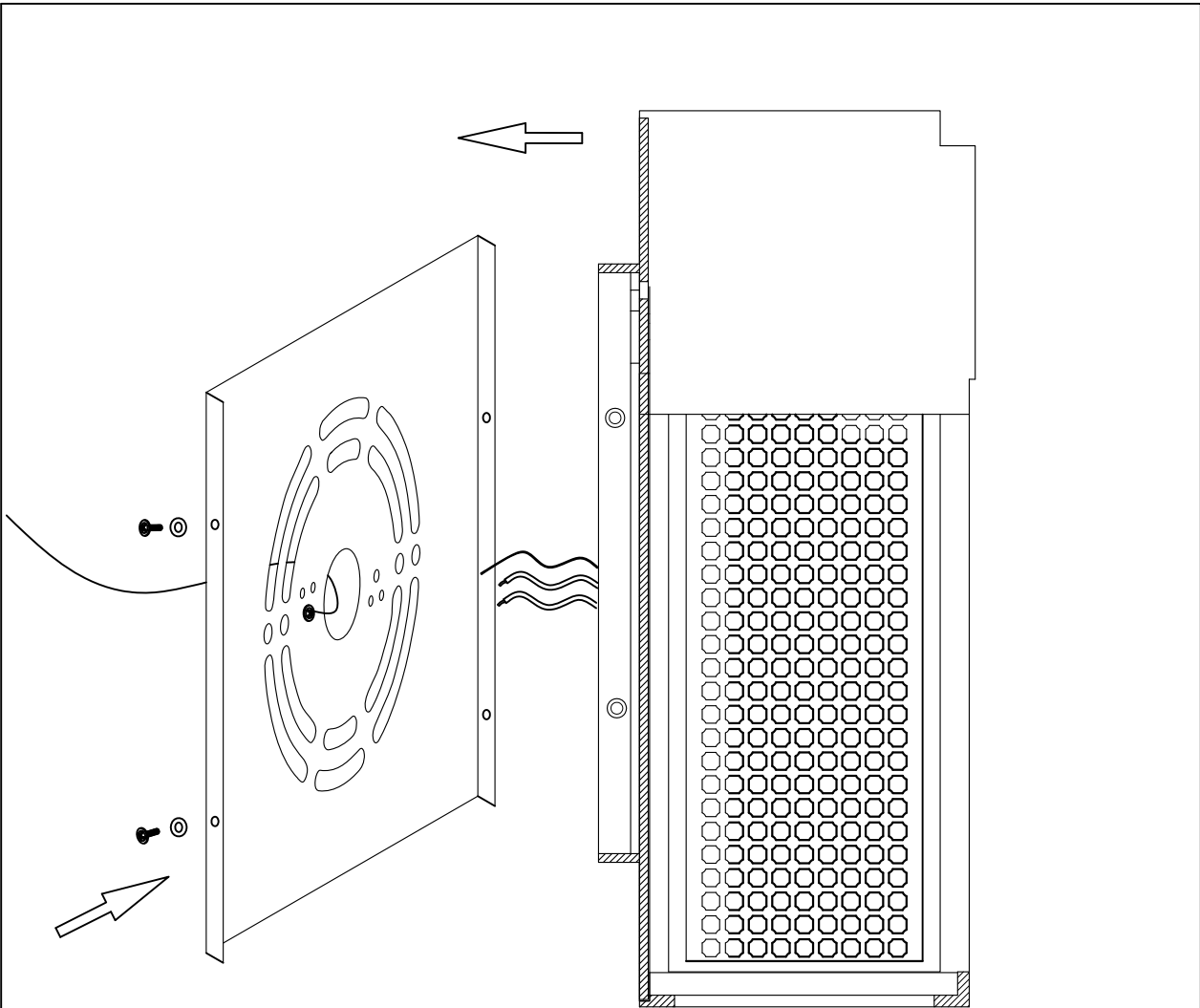

Installation Procedures

1. Remove mounting bracket from fixture and install to electrical box.
2. Wire fixture to wires in outlet box. Copper wire is for Ground.
3. Attach fixture to mounting bracket and tighten screws on the side so fixture meets wall.

(For outdoor use, caulk fixture with silicone sealant)